

Official Pickleball Net

Item # W13821

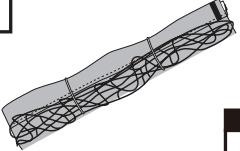
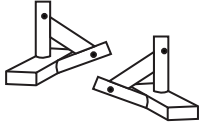
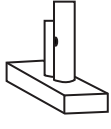
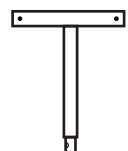
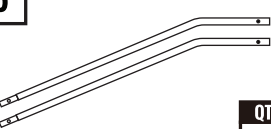
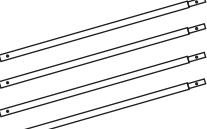
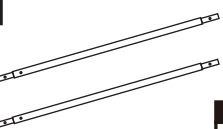
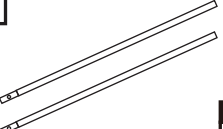
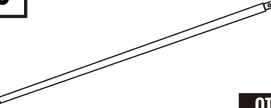
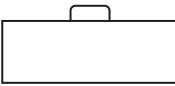

PARTS LIST

<p>1</p>  <p>QTY x1</p> <p>Official Sized Net</p>	<p>2</p>  <p>QTY x2</p> <p>Base Stand (End)</p>	<p>3</p>  <p>QTY x1</p> <p>Base Stand (Center)</p>	<p>4</p>  <p>QTY x1</p> <p>Frame (Center Support)</p>
<p>5</p>  <p>QTY x2</p> <p>Frame (Angled Tubing)</p>	<p>6</p>  <p>QTY x4</p> <p>Single Male Frame (Straight Tubing)</p>	<p>7</p>  <p>QTY x2</p> <p>Double Male Frame (Straight Tubing)</p>	<p>8</p>  <p>QTY x2</p> <p>Frame (End Net Pole)</p>
<p>9</p>  <p>QTY x1</p> <p>Frame (Center Net Pole)</p>	<p>10</p>  <p>QTY x1</p> <p>Heavy Duty Carry Bag</p>		

ASSEMBLY INSTRUCTIONS

GENERAL NOTE

1. Find a large clean area to assemble your PICKLEBALL-X® OFFICIAL NET.
Note: Once finished this item will be about 22ft (6.7m) long.

2. Remove all the parts from the box and verify that you have all of the listed parts as shown on the parts list page.

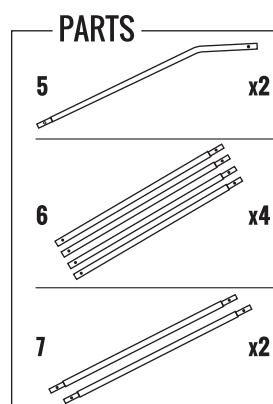
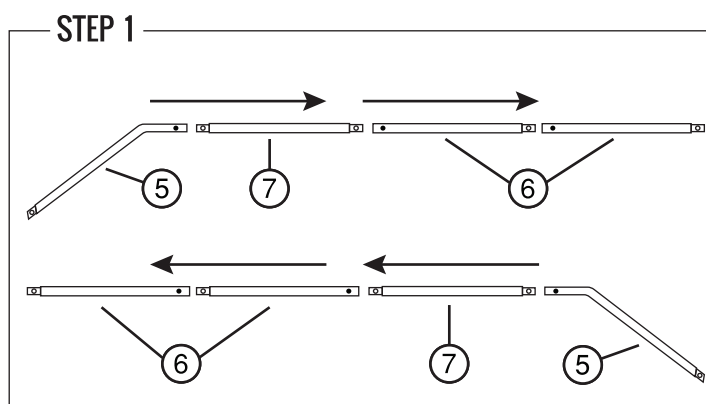

STEP 2

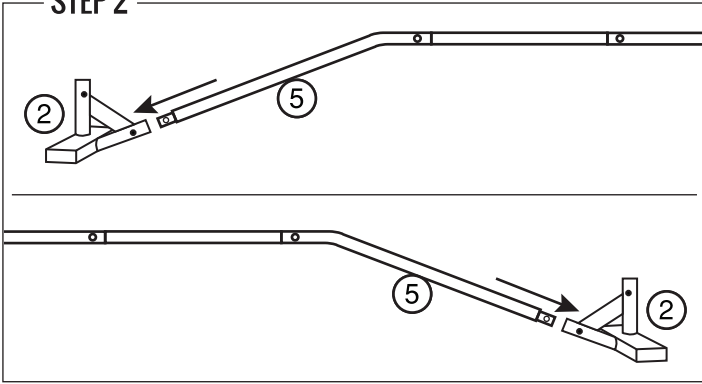

PARTS

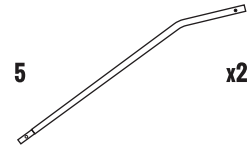
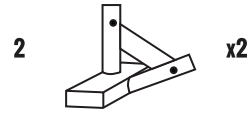

STEP 3

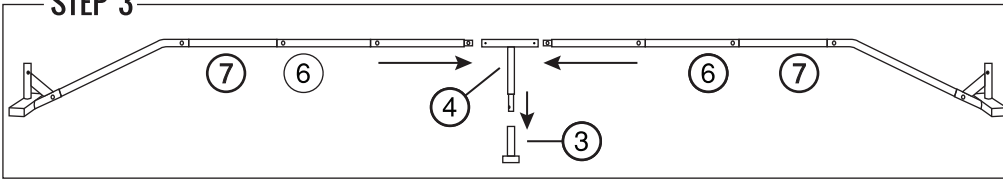

PARTS

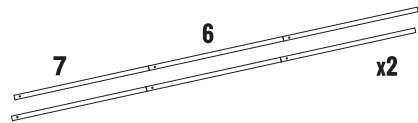
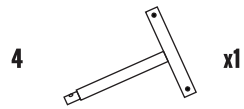
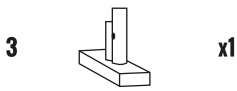

STEP 4

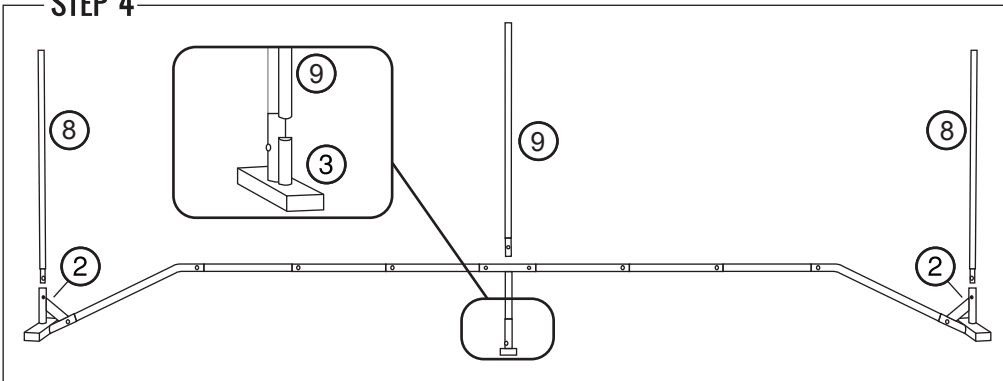

PARTS

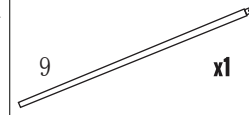
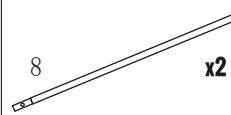
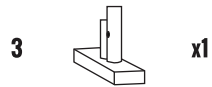
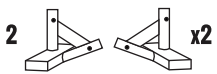

STEP 5

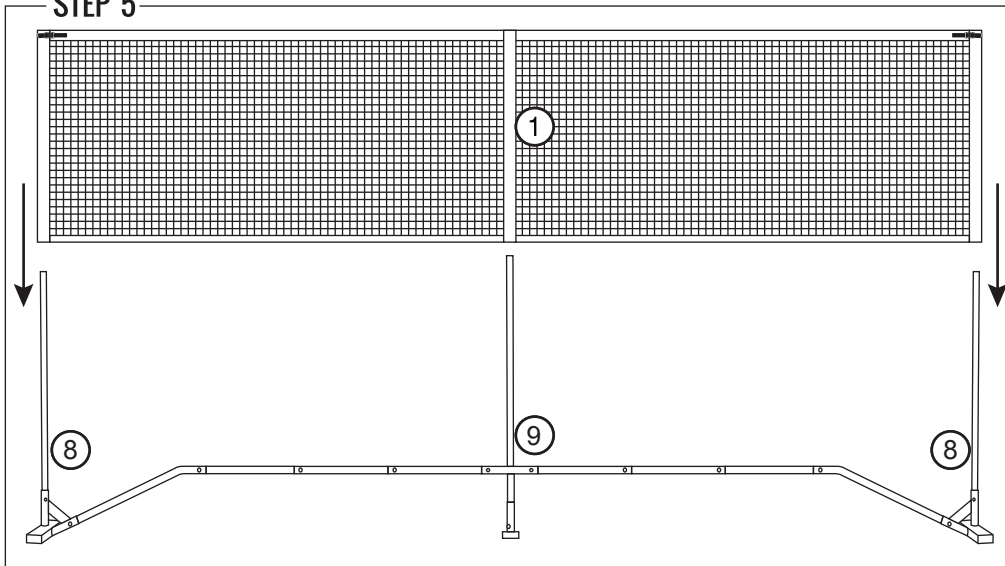

PARTS

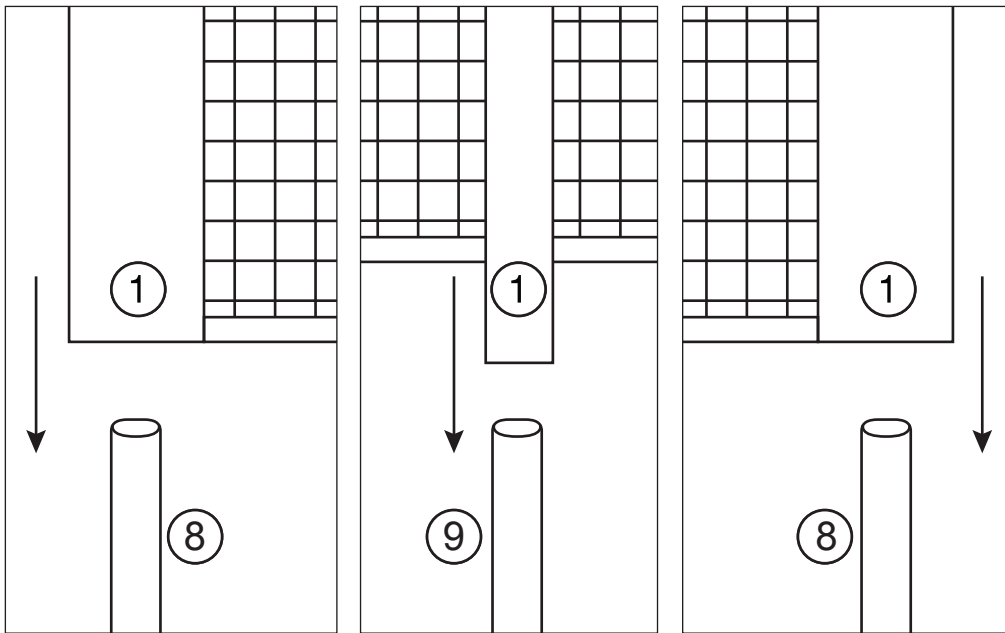
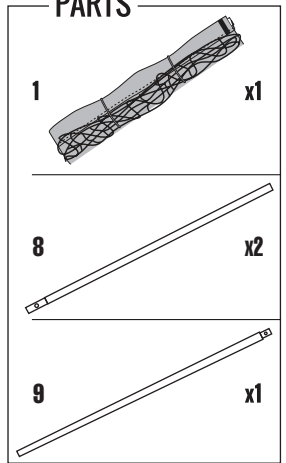

STEP 6

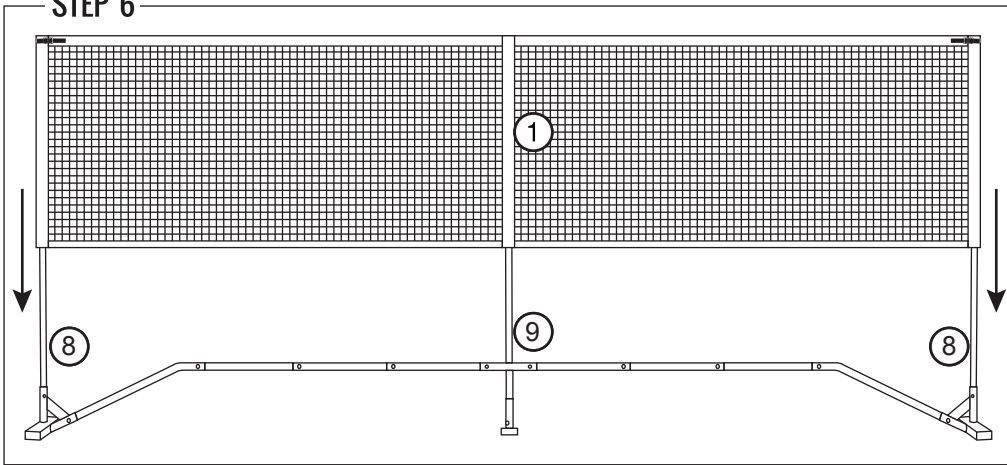

PARTS

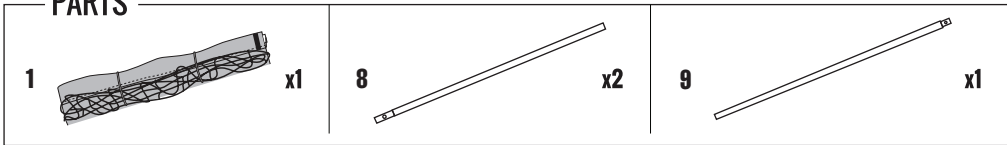

STEP 6A

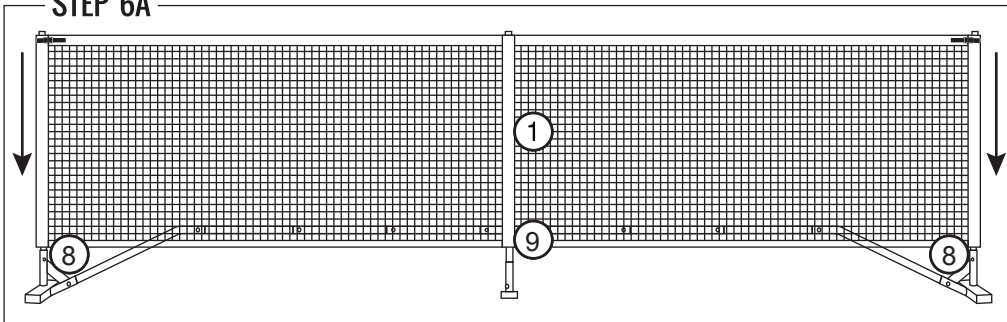

PARTS

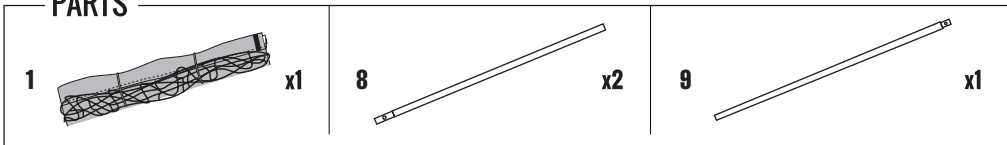

STEP 7

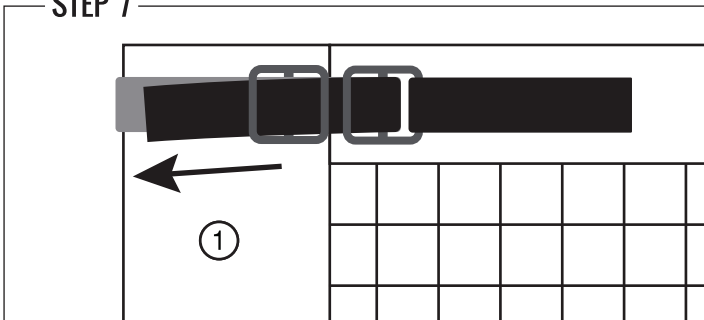

PARTS

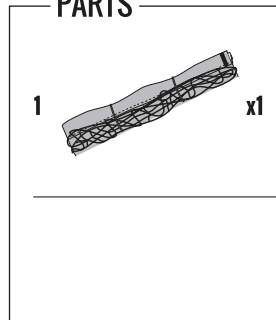

YOU ARE NOW READY TO PLAY!

